

twilight

INSTRUMENTOS DE MEDICIÓN INDUSTRIAL

MANUAL

HZ-PTQA30

Balanza Digital con Cap. de 30kg 40kg marca Huazhi

SAFETY

- For avoiding damage, please read all operating instructions carefully before use.
- ⚠ Don't use your machine under dangerous working circumstance.
- ⚠ Cut off the power if machine will turn off for more than one week.
- ⚠ Turn off the machine and cut off the power before or after connection with other equipments.
- ⚠ Strong magnetic field and static electricity can have an adverse effect on weighing sensor. When disturbance disappear, the machine will work well again.

Warning

- All our parts is the most suitable parts for machine.
All modification or using unauthorized parts for machine need to be confirm before using.
All modification needs to be take responsibility.
- Do not open the machine housing. Machine will not have guarantee service if security label broken.

1. Unpacking

- After unpacking the machine, please check machine has any visible damage.
- Please keep the original box and packing material for storing machine when not in use or send back for repairing.
Before packing the balance, please cut off all power and cable.

2. Installation

When select the location for install machine, please keep these tips in mind:

- Do not put machine close to central heating or sunshine and airflow way.
(Opening door or window)
- Do not exposure machine to extreme heat or cold. Keep scale in a clean, dry location. Dust, dirt and moisture can accumulate on the weighing sensor.
- Install machine on a flat and level surface, free from vibration and drafts, free from corrosive and strong magnetic field, as they can have an adverse effect on the weighing sensors.

3. Warm up for machine adapt temperature

When move machine from high temperature place to low temperature place (or inversely), please keep machine in final place for two hours and then turn on to warm up (warm up time refer to the specification list), as the machine will proportion the room temperature.

Summarize

4. Key Explanation

UNIT KEY (Move Key)

- A: Select Unit.
- B: Status 1: Move the flash on digit to left.
- C: Status 2: When all digit flash, press UNIT KEY and let single digit flash, enter into status 1. Press UNIT KEY again enter into status 2. It is circle.
- D: Status 3: When set parameter, press UNIT KEY can minus one. (At this moment)

MENU KEY

- A: Press and Hold MENU KEY for 5 seconds will enter into system setting menu.
- B: Press and Hold MENU KEY for 1 second will save and quit system setting menu.
- C: Short press MENU KEY to alternately display system menu, but if only one parameter in this level, short press MENU KEY will return to previous menu.

CAL KEY (Enter Key)

- A: When normal weighing, short press CAL KEY will zeroing.
- B: Press and hold CAL KEY for 5 seconds will enter into calibration.
- C: Enter into submenu.
- D: At the bottom menu, press CAL KEY will confirm the present status and return to: (1) The previous menu
(2) Enter into a weighing function (such as density, dynamic)
- E: Under COD STATUS (Engineer Parameter Setting Status) Input different code will enter into correspond parameter menu.

PRINT KEY (Cycle Key)

- A: When manual printing or communication available, press PRINT KEY will send weighing data to printer or other equipment.
- B: When one digit flash , press PRINT KEY will plus one.
- C: Cycle to next parameter when display flash.

TARE KEY (Return Key)

- A: Tare.
- B: Return to the previous menu without save.
- C: Press and hold PRINT KEY for 1 second will quit from a weighing function. (Such as density, dynamic)

Note: The buzzer sound different when long press or short press the key.

5. Display Explanation

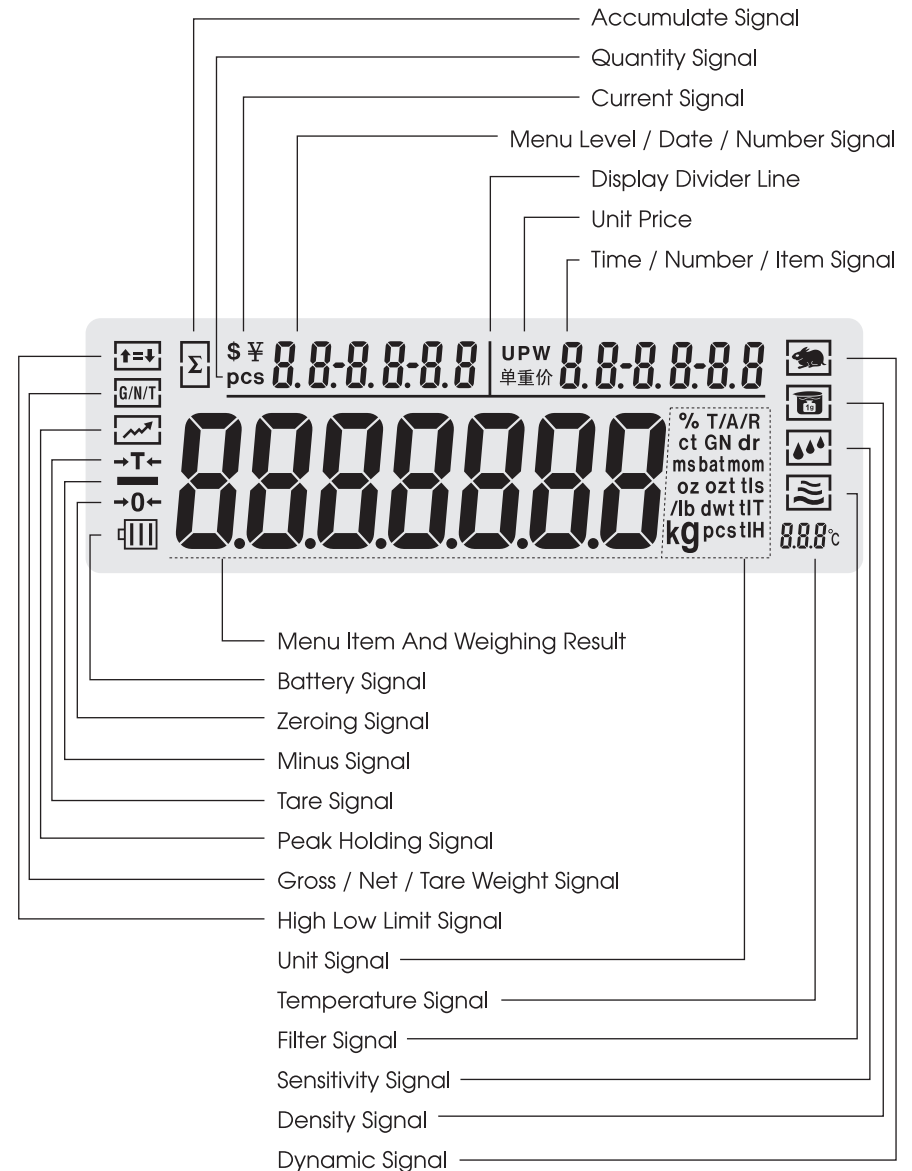

Second Part: Installation

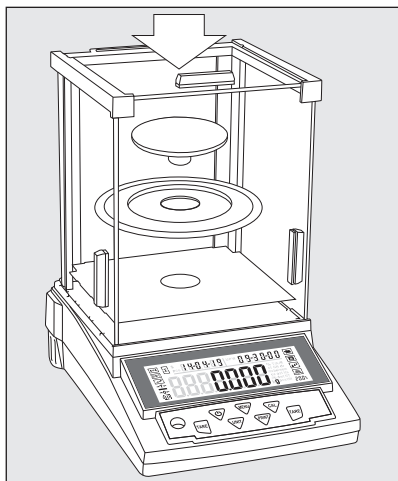

Assemble Machine

The machine with windshield

- Assemble each parts as following :
 - Air-free loop
 - Put weighing pan on the pillar which is in the middle of machine.

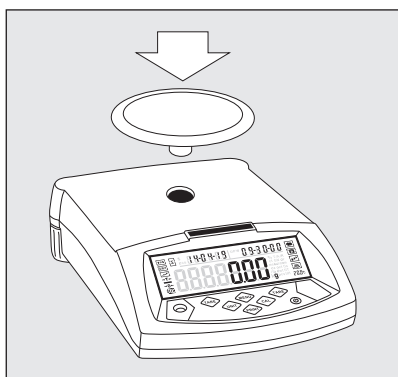

The machine with round weighing pan

- Put weighing pan on the pillar which is in the middle of machine.

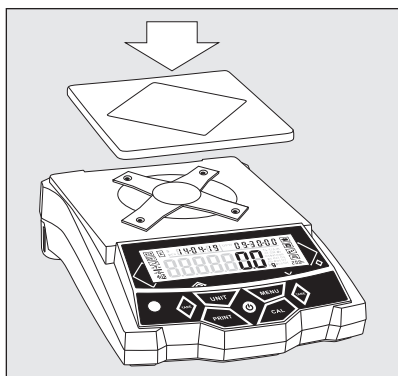

The machine with square weighing pan

- Put the weighing pan on bracket.

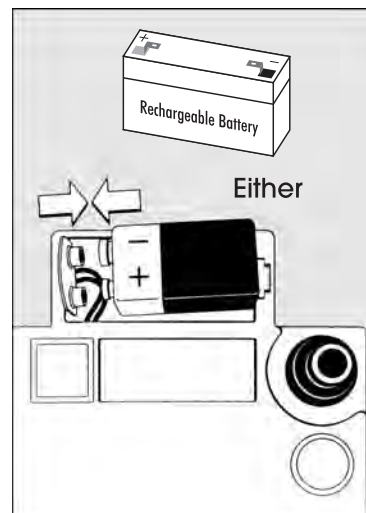

Use dry battery / Rechargeable battery (Optional)

- The dry battery or rechargeable battery is not on machine's packing list.
- ⚠ Only normal or universal 9V dry battery or rechargeable battery will be available for machine.
- ⚠ Only available for using adapter to recharge the rechargeable battery for machine.
- Lie down the machine at side.
- Open the battery box cover.
- Connect and put 9V dry battery or rechargeable battery in box.
- Confirm the positive and negative correctly.
- Close the battery box: Screw the battery box cover adown to the machine.
- ⚠ The used battery is recycled. According to the waste disposal law, rechargeable battery to be used as a special garbage recycling and specialized handling.

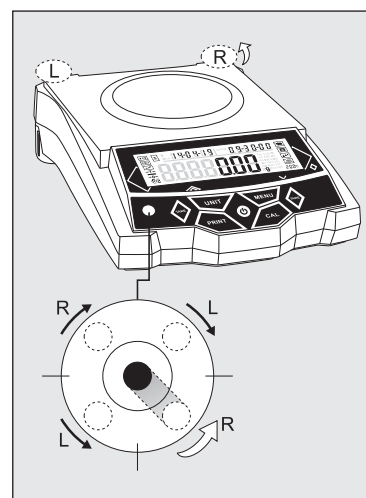

Adjust Machine Level

The machine need to adjust the level ever time when change the install location. Moving the two back screw nuts slowing to adjust level.

- Counterclockwise rotate the two back screws to right position.
- Rotate the screws as the photo until the bubble is in the middle of level device.
- Clockwise rotate the two back screws until it touch the supporter.
- > Under normal circumstances, adjust level need several times to reach suitable position.

Third Part: Machine Detail Specification Cable

● Single Range, s: Factory standard with Automatic Internal Calibration, a: Factory standard with Internal Calibration

Item No.	Weighing Range(g)	Readability (mg)	Repeat-ability(mg)	Linearity (mg)	Operate Temp(°C)	Pan Size (mm)	Housing Size (LxWxH)(mm)	Warm-up Time (m)		
	120 / 30	0.1 / 0.01	± 0.1 / ± 0.01	± 0.2 / ± 0.02	20 ± 2.5	∅ 90	295x205x315	30-60		
	220 / 40									
s	120 / 30									
s	220 / 50									
s	120 / 220	0.1 / 0.5	± 0.1 / ± 1	± 0.2 / ± 2	20 ± 2.5	∅ 90	295x205x315	30-60		
s	220 / 320									
s	320 / 420									
s	220 / 320	1 / 2	± 1 / ± 2	± 2 / ± 4	20 ± 2.5	∅ 90	295x205x315	30-60		
s	320 / 420									
s	420 / 520									
s	520 / 620					∅ 108				
s ●	620								± 1	± 2
●	1000								± 2	± 3
a	110	0.1	± 0.1	± 0.2	20 ± 2.5	∅ 90	345x223x331	30-60		
a	210									
a	300									
	210	1	± 1	± 2	20 ± 7.5	∅ 108				
	510									
	1000									
●	2200	10	± 10	± 20	20 ± 7.5	168 x 190	345x223x110	20-30		
●	3200									
●	4200									
●	5200									
●	6200									
s	220	1	± 1	± 2	20 ± 7.5	∅ 90	295x205x255	30-60		
s	520									
	1000									
s	520								10	± 10
	1000									
	2000									

Item No.	Weighing Range(ct)	Readability (ct)	Repeat-ability(ct)	Linearity (ct)	Operate Temp(°C)	Pan Size (mm)	Housing Size (LxWxH)(mm)	Warm-up Time (m)	
s	550	1	± 1	± 2	20 ± 2.5	∅ 90	295x205x255	30-60	
s	800								
s	1100								
Item No.	Weighing Range(g)	Readability (mg)	Repeat-ability(mg)	Linearity (mg)	Operate Temp(°C)	Pan Size (mm)	Housing Size (LxWxH)(mm)	Warm-up Time (m)	
	120 / 220	1 / 5	± 2 / ± 5	± 2 / ± 5	20 ± 7.5	∅ 90	295x208x305	10 - 20	
	220 / 320								
	320 / 420								
●	420	1	± 2	± 2					
Item No.	Weighing Range(g)	Readability (mg)	Repeat-ability(mg)	Linearity (mg)	Operate Temp(°C)	Pan Size (mm)	Housing Size (LxWxH)(mm)	Warm-up Time (m)	
	220 / 620	0.01 / 0.05	± 0.01 / ± 0.05	± 0.02 / ± 0.05	10 - 35	∅ 133	295x208x305 (295x208x88)	10-20	
	320 / 620								
	520 / 1200								
	620 / 2200					± 0.02 / ± 0.05			± 0.03 / ± 0.10
	1200 / 2200								
	2200 / 3200								
	3200 / 4200	0.01	± 0.02	± 0.03		156 x 156			
●	4000					168 x 168			
	1200 / 2200	0.1 / 0.2	± 0.1 / ± 0.2	± 0.2 / ± 0.2	10 - 35	∅ 133	295x208x88	10-20	
	2200 / 4200								
	3200 / 5200								
	5200 / 10000								
	6200 / 10000								
Item No.	Weighing Range(kg)	Readability (mg)	Repeat-ability(mg)	Linearity (mg)	Operate Temp(°C)	Pan Size (mm)	Housing Size (LxWxH)(mm)	Warm-up Time (m)	
	2 / 3	0.01 / 0.02	± 0.01 / ± 0.02	± 0.02 / ± 0.04		180 x 255			
	3 / 4								
●	4	0.01	± 0.02	± 0.02					
	10 / 20	0.1 / 0.5	± 0.1 / ± 0.5	± 0.2 / ± 1					
	15 / 30								
	20 / 30								
	30 / 40	0.1 / 0.2	± 0.1 / ± 0.2	± 0.2 / ± 0.4	10 - 35	205 x 295	320x310x120	10-20	
	50 / 10								
	15 / 30	1 / 2	± 1 / ± 2	± 2 / ± 4					
	20 / 30								
	30 / 50								
	50 / 70								
	50 / 70								

Basic Weighing Function

Preparation

- Turn on machine: Press (ON/OFF) Key

Warm up time:



- For making sure the weighing result correct, different type machine need different warm up time to reach the required operating temperature. Please refer the specification list to know the correct warm up time.

Calibration

- The machine need calibration before using. For the calibrations step, please refer to 43-46 pages in detail.

INSTANCE

Basic Weighing (The machine was warm up)

Key (Order)	Step Explanation	LCD Screen Display
	1. Zero Stable	
	2. Put container on weighing pan (Example: 100g)	100.00 g
[TARE]	3. Press Tare key for tare the container weight	0.00 g
	4. Put sample in container (Example: 200g)	200.00 g

Unit Switching

Press (UNIT) Key, the weighing unit will cycle between the different weighing units with each press of the button. The balance will default to the last unit used when turned on the next time.

Unit Signal	Unit	Unit Exchange Rate
g	Gram	1
ct	Carat	5
oz	Ounce	0.03527396200
ozt	Troy Ounce	0.03215074700
dwt	Pennyweight	0.64301493100
GN	Grains	15.43235835000
lb	Pound	0.00220462260
N	Newton	0.00980654189
dr	Dram	0.56438222222
tIT	Taiwan Tael	0.02666666000
tIs	Singapore Tael	0.02645544638
tIH	Hong Kong Tael	0.02671725000
T	Tola	0.08573532418
T/A/R	tola / anna / rati T.A.R	0 . 01 . 2 . 23
/A/R	tola / Mna / rati T.M.R	0 . 01 . 0 . 23
ms	Mesghal	0.21700000000
bat	Baht	0.06578947437
mom	momme	0.26670000000
/lb	Parts per pound	1.12876677120
kg	Kilogram	0.00100000000

Application Setting (Menu Code: 1)

Counting (Menu Code: 1.1.)

Purpose

Use this function can calculate the quantity with total weight divide by signal weight.

(1) Counting Instance: with known the sample's quantity but unknown the unit weight

Key (Order)	Step Explanation	LCD Screen Display	Menu Level and Code
Press and Hole [MENU] Key	1. Enter Into Menu	- - ñodE -	1.
Short Press [CAL] Key	2. Display Counting Mode	- [COUNT] -	1.1.
Short Press [CAL] Key	3. Enter into Counting Program	SAMPLE	1.1.1
Short Press [CAL] Key	4. Flash the sample quantity 20pcs(Example) ○ Press [PRINT] key to cycle the sample quantity and select ○ User can set the quantity manually: Press [UNIT] key to move the cursor and press [PRINT] key to increase the number.	0000020 pcs	1.1.1.1
Short Press [CAL] Key	5. Put 20 pieces to platform or container (Example: 20pcs, unit weight:0.11mg).		
Short Press [CAL] Key	6. The display will show the result ○ Three position to display the result as: Upper left display quantity: 20pcs, Upper right display unit weight: 0.11mg, Main window display total weight 2.200mg	<div style="display: flex; justify-content: space-between;"> pcs 20 u 0.11000 2.200 g </div>	
Short Press [CAL] Key	7. Take samples away	0000 g	
Short Press [CAL] Key	8. Put any unknown numbers of pieces on pan and will display a count. (Example: put 1 00pcs, total weight 11 mg) ○ Three position to display the result as : Upper left display quantity: 100pcs, Upper right display unit weight: 0.11g, Main window display total weight 11.000mg	<div style="display: flex; justify-content: space-between;"> pcs 100 u 0.11000 11.000 g </div>	
Press and Hole [TARE] Key	9. Exit the counting function.		

● Quick restart: exit the present counting and restart a new counting, Press and hold [MENU] key can restart the step 1, short press [CAL] to enter into step 3.

Note: The grey color words explain the signal's meaning which flash on the window.

(2) Counting Instance: with known the sample's quantity and the unit weight

Key (Order)	Step Explanation	LCD Screen Display	Menu Level and Code
Press and Hole [MENU] Key	1. Enter Into Menu	- - ñodE -	1.
Short Press [CAL] Key	2. Display Counting Mode	- [COUNT] -	1.1.
Short Press [CAL] Key	3. Enter into Counting Program	SAMPLE	1.1.1
Short Press [MENU] Key	4. Display Setting Menu	1 NPUR	1.1.2.
Short Press [CAL] Key	5. Flash Sample Quantity (Example: 20pcs) ○ Press [PRINT] key to cycle the sample quantity setting ○ User can set sample quantity manually: Press [UNIT] key to move the cursor and press [PRINT] key to increase the number.	0000020 pcs	1.1.2.1
Short Press [CAL] Key	6. Flash Sample Unit Weight ○ User can set sample unit weight: Press [UNIT] key to move the cursor and press [PRINT] Key to increase the number.	0002000 g	1.1.2.2
Short Press [CAL] Key	7. The display will show the result ○ Three position to display the result as: Upper left display quantity, Upper right display unit weight: 0.1 g, Main window display total weight 0.000mg	<div style="display: flex; justify-content: space-between;"> pcs 0 u 0.10000 0.000 g </div>	
Short Press [CAL] Key	8. Put any unknown numbers of pieces on pan and will display a count. (Example: 300pcs) ○ Three position to display the result as: Upper left display quantity 300pcs, Upper right display unit weight: 0.1g, Main window display total weight 30.000mg	<div style="display: flex; justify-content: space-between;"> pcs 300 u 0.10000 30.000 g </div>	
Press and Hole [TARE] Key	9. Exit the counting function.		

● Quick restart: exit the present counting and restart a new counting, Press and hold [MENU] key can restart the step 1, short press [CAL] to enter into step 3.

Note: The grey color words explain the signal's meaning which flash on the window.

Computing Price Function (Menu Code: 1.2.)

Purpose

Count total amount according to the known price and quantity.

Instance

Key (Order)	Step Explanation	LCD Screen Display	Menu Level and Code
Press and Hole [MENU] Key	1. Enter Into Menu	--n0dE-	1.
Short Press [CAL] Key	2. Display Counting Mode	-COUNT-	1.1.
Short Press [MENU] Key	3. Display Computing Price Function Mode <i>Flash the signal of total and unit price on window upper side</i>	-Pr iEE-	1.2.
Short Press [CAL] Key	4. Setting sample's pricing weight (Example: 1mg) ○ Setting Way: Press [UNIT] key to move digit, press [PRINT] key to increase the number and press [CAL] key to confirm.	000 1000 g	1.2.1
Short Press [CAL] Key	5. Setting sample's unit price (Example: 3us dollar) ○ Setting Way: Press [UNIT] key to move digit, press [PRINT] key to increase the number and press [CAL] key to confirm.	0000 300	1.2.2
Short Press [CAL] Key	6. Confirm the sample's pricing weight and unit price ○ Three position to display as: Upper left display total amount \$0.00, Upper right display unit price: \$3.00, Main window display total weight 0.000mg	0.00 3.00000 0000 g	
Short Press [CAL] Key	7. Put products on pan and machine will display result. (Example: 20mg) ○ Three position to display as: Upper left display total amount \$60.00, Upper right display unit price: \$3.00, Main window display total weight 20.000mg	60.00 3.00000 20.000 g	
Press and Hole [TARE] Key	8. Exit the computing price function.		

● Quick restart: exit the present computing price and restart the new one, Press and hold [MENU] key can restart the step 1, short press [CAL] to enter into step 3.

Note: The grey color words explain the signal's meaning which flash on the window.

High Low Limit Alarm Function (Menu Code: 1.3.)

Purpose

Weighing the target sample's weight or quantity in or out the setting limit and alarm.

Instance

Key (Order)	Step Explanation	LCD Screen Display	Menu Level and Code
Press and Hole [MENU] Key	1. Enter Into Menu System	--n0dE-	1.
Short Press [CAL] Key	2. Display Counting Mode	-COUNT-	1.1.
Short Press [MENU] Key Two Times	3. Display High Low Limit Mode <i>Flash the signal of High Low Limit at the left side of window</i>	-AL AL n-	1.3.
Short Press [CAL] Key	4. Display ALR and flash IN or OUT ○ Press [PRINT] key to set machine alarm in (IN) or out (OUT) the limit, press [CAL] to confirm Setting IN, the machine will beep if the sample's weight is within the setting limit. Setting OUT, the machine will beep if the sample's weight is without the setting limit.	ALr -OUT	1.3.1
Short Press [CAL] Key	5. Setting the High Limit (Example : 200mg) ○ Three position to display as: Upper left display menu code:1.3.2 , Upper right display HIGH, Main window display the High Limit value Input way: Press [UNIT] key to move the flash digit, press [PRINT] key to increase the number and press [CAL] key to confirm.	1.3.2 HIGH 0200000 g	
Short Press [CAL] Key	6. Setting the Low Limit (Example: 180mg) ○ Three position to display as: Upper left display menu code:1.3.3 , Upper right display LOW, Main window display the Low Limit value Input way: Press [UNIT] key to move the flash digit, press [PRINT] key to increase the number and press [CAL] key to confirm.	1.3.3 LOW 0 1800000 g	
Short Press [CAL] Key	7. Put samples on pan and machine will display result. (Example: 186mg) ○ Three position to display as : Upper left display high limit 200mg, upper right display Low limit 180mg, the main window display the samples weight and beep, to mention that sample's weight is in the setting limit.	200.000 180.000 186.000 g	
Press and Hole [TARE] Key	8. Exit the high low limit alarm function.		

● Quick restart: exit the present high low limit alarm and restart the new one, Press and hold [MENU] key can restart the step 1, short press [CAL] to enter into step 3.



Note: The grey color words explain the signal's meaning which flash on the window.

Gross / Net / Tare Weight Weighing Function (Menu Code:1.4.)

Purpose

To weigh and display the sample's gross weight, net weight and tare weight intuitively.



(1) G/N/T Weight Weighing Instance

Key (Order)	Step Explanation	LCD Screen Display	Menu Level and Code
Press and Hole [MENU] Key	1. Enter Into Menu System	-- nodE --	1.
Short Press [CAL] Key	2. Display Counting Mode	- COUNT -	1.1.
Short Press [MENU] Key Three Times	3. Display G/N/T weight weighing mode <i>Flash the G/N/T signal on the left side of window</i>	-- GNF --	1.4.
Short Press [CAL] Key	4. Enter into G/N/T mode	S R nPLE	1.4.1
Short Press [CAL] Key	5. The display flash to remind to put the tare weight of sample	S R nPLE	1.4.1.1
 Short Press [CAL] Key	6. Put tare weight of sample on pan	S R nPLE	
Short Press [CAL] Key	7. Confirm the tare weight (Example 200mg)	<u>0000</u> <u>200.000</u> 0000g	
	○ Three position to display as: <i>Upper left display gross weight 200mg, Upper right display tare weight 200g, Main window display 0.000mg</i>		
 Short Press [CAL] Key	8. Put samples on pan and machine will display result (Example: 25.3mg)	<u>225.300</u> <u>200.000</u> 25.300g	
	○ Three position to display as: <i>Upper left display gross weight 225.3mg, Upper right display tare weight 200g, Main window display net weight: 25.300mg</i>		
Press and Hole [TARE] Key	9. Exit G/N/T weight weighing function		

● Quick restart: exit the present G/N/T weight weighing and restart the new one, Press and hold [MENU] key can restart the step 1, short press [CAL] to enter into step 3.

Note: The grey color words explain the signal's meaning which flash on the window.

(2) To Input the Tare Weight Instance

Key (Order)	Step Explanation	LCD Screen Display	Menu Level and Code
Press and Hole [MENU] Key	1. Enter Into Menu System	-- nodE --	1.
Short Press [CAL] Key	2. Display Counting Mode	- COUNT -	1.1.
Short Press [MENU] Key Three Times	3. Display G/N/T weight weighing mode <i>Flash the G/N/T signal on the left side of window</i>	-- GNF --	1.4.
Short Press [CAL] Key	4. Enter into G/N/T mode	S R nPLE	1.4.1
Short Press [MENU] Key	5. Enter into G/N/T mode of input tare weight manually	I NP UF	1.4.2.
Short Press [CAL] Key	6. Input the tare weight manually (Example: 200mg) ○ Input way: Press [UNIT] key to move the flash digit, press [PRINT] key to increase the number and press [CAL] key to confirm	0200000g	1.4.2.1
Short Press [CAL] Key	7. Confirm the entered tare weight ○ Three position to display as: <i>Upper left display gross weight 0.000mg, Upper right display tare weight 200g, Main window display net weight: -200.000mg</i>	<u>0000</u> <u>200.000</u> -200000g	
 Short Press [CAL] Key	8. If put the sample of tare weight (Example:200mg) ○ Three position to display as: <i>Upper left display gross weight 200mg, Upper right display tare weight 200g, Main window display 0.000mg</i>	<u>200.000</u> <u>200.000</u> 0000g	
 Short Press [CAL] Key	9. Put samples on pan and machine will display result. (Example: 309.3mg) ○ Three position to display as: <i>Upper left display gross weight 509.3g, Upper right display tare weight 200mg, Main window display net weight: 309.300mg</i>	<u>509.300</u> <u>200.000</u> 309.300g	
Press and Hole [TARE] Key	10. Exit G/N/T weight weighing function		

● Quick restart: exit the present G/N/T weight weighing and restart the new one, Press and hold [MENU] key can restart the step 1, short press [CAL] to enter into step 3.



Note: The grey color words explain the signal's meaning which flash on the window.

Accumulate Function (Menu Code:1.5.)

Purpose

Weighing and accumulating the several sample's total weight and tracing the detail data.

Instance

Key (Order)	Step Explanation	LCD Screen Display	Menu Level and Code
Press and Hole [MENU] Key	1. Enter Into Menu System	-- $\bar{n}odE$ --	1.
Short Press [CAL] Key	2. Display Counting Mode	-COUNT-	1.1.
Short Press [MENU] Key Four Times	3. Display Accumulate Menu The signal flash on the upper left of window	--Add--	1.5.
Short Press [CAL] Key	4. Enter Into Accumulate Mode	$\frac{0.0000}{0000} \text{ g. } 0$	
	○ Three position to display as : Upper left display present weight 0.000mg, Upper right display total time 0, Main window display total weight 0.000mg		
	5. Put samples on pan and press [CAL] key to confirm weight	$\frac{10.0000}{10000} \text{ g. } 1$	
	○ Three position to display as: (Example: 10gm) Upper left display present weight 10mg, Upper right display total time 1, Main window display total weight 10.00mg		
	6. Put sample several times and press [CAL] key each time	$\frac{30.0000}{60000} \text{ g. } 3$	
	○ Three position to display as (example: sample's weight is 10mg, 20mg, 30mg): Upper left display present weight 30mg, Upper right display total time 3, Main window display total weight 60.000mg		
	○ Under the accumulate mode, the accumulate weight can be 9999999mg, can accumulate 9999 times.		
Press [MENU] Key and hold it, press [CAL] Key, release two key at the same time	7. Enter into tracing data function, the machine show the last accumulate time's data	$\frac{30.0000}{60000} \text{ g. } 3$	
	○ Three position to display as: Upper left display present weight 30mg, Upper right display total time 3, Main window display total weight 60.000mg		

Short Press [UNIT] Key 8. Tracing the second last time's weighing data $\frac{20.0000}{30000} \text{ g. } 2$

○ Three position to display as:
Upper left display present weight 20mg, Upper right display total time 2, Main window display total weight 30.000mg

Short Press [UNIT] Key 9. Tracing the first time's accumulate data for instance weighing $\frac{10.0000}{10000} \text{ g. } 1$

○ Three position to display as:
Upper left display present weight 10mg, Upper right display total time 1, Main window display total weight 10.000mg

- Press (UNIT) Key and (PRINT) Key can view the different accumulate time's result of present weighing.
- Only can save and trace 100 times accumulate weighing data. Machine can not save and trace if exit or restart the accumulate weighing.

Press and Hole [CAL] Key 10. Quick restart way: exit the accumulate weighing and restart the new one $\frac{0.0000}{0000} \text{ g. } 0$

○ Three position to display as:
Upper left display present weight 0g, Upper right display total time 0, Main window display total weight 0.000mg.

Press and Hole [TARE] Key 11. Exit the accumulate weighing

- Quick restart: exit the present accumulate weighing and restart the new one, Press and hold [MENU] key can restart the step 1, short press [CAL] to enter into step 3.

Dynamic Measurement (Menu Code:1.6.)

Purpose

Operator can use this program to measure dynamic weight. The dynamic weighing way is summarize the weighing result from setting time and average it.

Instance

Set 10 seconds for the dynamic weight material or variable weight material.

Key (Order)	Step Explanation	LCD Screen Display	Menu Level and Code
Press and Hole [MENU] Key	1. Enter Into Menu System	--ñodE-	1.
Short Press [CAL] Key	2. Display Counting Mode	-[COUNT]-	1.1.
Short Press [MENU] Key Five Times	3. Enter Into Dynamic Measurement <i>The signal flash on the upper left of window</i>	0YHARñ [1.6.
Short Press [CAL] Key	4. Select Weighing Time ○ Press [PRINT] key can cycle and select different weighing time. (Second) ○ Operator can set the weighing time by: Press [UNIT] key to move cursor, press [PRINT] to select the target Number.	rd--- 10	1.6.1
Short Press [CAL] Key	5. Confirm the weighing time ○ Three position to display as: Upper left display present weight, Upper right display the setting time, Main window display: Start	0.0000 0.0 5.2827 g	
	6. When display flash: START, put weighing sample on pan	5.2827	
Short Press [CAL] Key	7. Start to weigh for 10 seconds	99.423 g	
Short Press [TARE] Key	8. Average the weighing result automatically after 10 seconds. ○ Three position to display as (Example: 98.423mg): Upper left display the dynamic value, Upper right display the weighing time, Main window displays the average value.	96.987 10.0 98.423 g	
	9. Clear the weighing data ○ (If need to measure different material, please repeat step 7-9.)	0.0000 g	
Press and Hole [TARE] Key	10. Exit the dynamic measurement		

● Quick Restart: exit the present dynamic weighing and restart the new one, press and hold [MENU] key can restart the step 1, short press [CAL] to enter into step 3.



Note: The grey color words explain the signal's meaning which flash on the window.

Peak Holding (Menu Code:1.7.)

Purpose

Sensing and saving the max weight during weighing, hold and display it.

(1) CNT Mode Instance of pressing key to record

Key (Order)	Step Explanation	LCD Screen Display	Menu Level and Code
Press and Hole [MENU] Key	1. Enter Into Menu System	--ñodE-	1.
Short Press [CAL] Key	2. Display Counting Menu	-[COUNT]-	1.1.
Short Press [MENU] Key Six Times	3. Display Peak Holding Menu <i>The signal flash on the upper left of window</i>	--PEAK-	1.7.
Short Press [CAL] Key	4. Display CNT Menu	REr CNT	1.7.1
Short Press [CAL] Key	5. Enter into CNT mode of pressing key ○ Three position to display as: Upper left display the present weight, Upper right display the number of weighing, Main window displays the max weighing weight.	0.0000 No. 0 0000 g	
	6. Put sample on pan and press [CAL] key to confirm it	10.0000 No. 1 10000 g	
	○ Three position to display as (Example: 10mg): Upper left display the present weight 10mg,, Upper right display the number of weighing:1, Main window displays the max weighing weight: 10mg		
	7. Put samples on pan several times and press [CAL] key each time.	15.0000 No. 2 18000 g	
	○ Three position to display as (Example: put three times with 10mg, 18mg and 15mg): Upper left display the present weight 15mg, Upper right display the number of weighing:2, Main window displays the max weighing weight: 18mg		
	○ The machine can operate 9999 times under Peak Holding mode		

Note: The grey color words explain the signal's meaning which flash on the window.

Press [MENU] Key and hold it, press [CAL] Key, release two key at the same time

8. Enter into tracing data function, the machine show the last peak holding time's data

fl a. 3 | 09-38-58
15.000g

- Three position to display as:
Upper left display the weighing No.3, Upper right display the time of that weighing, Main window displays the weight of that weighing: 15mg

Short Press [UNIT] Key

9. Tracing the second last time's weighing data

fl a. 2 | 09-38-55
18.000g

- Three position to display as:
Upper left display the weighing No.2, Upper right display the time of that weighing, Main window displays the weight of that weighing 18mg.

Short Press [UNIT] Key

10. Tracing the first time's peak holding data

fl a. 1 | 09-38-51
10.000g

- Three position to display as:
Upper left display the weighing No.1, Upper right display the time of that weighing, Main window displays the weight of that weighing 10mg.

- Press (UNIT) Key and (PRINT) Key can view the different peak holding time's result of present weighing.
- Only can save and trace 100 times peak holding data. Machine can not save and trace if exit or restart the peak holding.

Press and Hole [CAL] Key

11. Quick restart way: exit the present peak holding and restart the new one

0.000 | fl a. 0
0.000g

- Three position to display as:
Upper left display the present weight, Upper right display the number of weighing, Main window displays the max weighing weight.

Press and Hole [TARE] Key

12. Exit the peak holding function

- Quick Restart: exit the present peak holding and restart the new one, press and hold [MENU] key can restart the step 1, short press [CAL] to enter into step 3.

(2) Other Peak Holding record way Instance

Key (Order)	Step Explanation	LCD Screen Display	Menu Level and Code
Press and Hole [MENU] Key	1. Enter Into Menu System	--mode--	1.
Short Press [CAL] Key	2. Display Counting Menu	-COUNT-	1.1.
Short Press [MENU] Key Six Times	3. Display Peak Holding Menu The signal flash on the upper left of window	--PEAK--	1.7.
Short Press [CAL] Key	4. Display CNT peak holding	REr CNT	1.7.1
Short Press [PRINT] Key	4. Display TKEY peak holding	REr TKEY	1.7.2
Short Press [PRINT] Key	4. Display TST1 peak holding	REr TST1	1.7.3
Short Press [PRINT] Key	4. Display TST2 peak holding	REr TST2	1.7.4
Short Press [PRINT] Key	4. Display TCON peak holding	REr TCon	1.7.5

Short Press [CAL] Key

5. Enter into corresponding peak holding mode

0.000 | 09-39-50
0.000g

- Three position to display as:
Upper left display the present weight, Upper right display the weighing time, Main window displays the max weighing weight.



6. Put samples on pan several times and press [CAL] key.

10.000 | 09-39-52
10.000g

- Three position to display as (Example: 10mg):
Upper left display the present weight 10mg, Upper right display the time of weighing, Main window displays the max weighing weight: 10mg



7. Put samples on pan several times and press [CAL] each time to confirm

15.000 | 09-39-59
18.000g

- Three position to display as (Example : put three times with 10mg, 18mg and 15mg):
Upper left display the present weight 15mg, Upper right display the time of weighing, Main window displays the max weighing weight: 18mg
- The machine can operate 9999 times under Peak Holding mode.

- TKEY mode is by pressing (CAL) Key to record the peak holding value and weighing time, upper right window display the peak holding time.
- TST1 mode is record the peak holding value and time automatically when weighing result very stable, upper right window display the peak holding time.
- TST2 mode is record the peak holding value and time automatically when weighing result a little stable, upper right window display the peak holding time.
- TST2 mode is record the peak holding value and time continuously, upper right window display the peak holding time.

- Tracing or Exit the peak holding function is the same in page 21~22, step 8~12.



Note: The grey background part is the step of 1-4 setting information after CNT mode, select any one mode, the mode will work at once. The grey color words explain the signal's meaning which flash on the window.

Percentage Measurement (Menu Code:1.8.)

Purpose

Operator place the reference sample that corresponds to 100% onto weighing pan, the other samples will display the weighing result as %. Operator can input the sample value or weighing the sample value and input it.

(1) Instance of Percentage Measurement with Sample

Key (Order)	Step Explanation	LCD Screen Display	Menu Level and Code
Press and Hole [MENU] Key	1. Enter Into Menu System	-- h0dE --	1.
Short Press [CAL] Key	2. Display Counting Menu	- COUNT -	1.1.
Short Press [MENU] Key Seven Times	3. Enter Into Percentage Measurement Display signal "%" on window	PERCENT %	1.8.
Short Press [CAL] Key	4. Select percentage weighing mode with (SAMPLE)	SAMPLE %	1.8.1.
Short Press [CAL] Key	5. Mention to start	SAMPLE	1.8.1.1
	6. Put sample	SAMPLE	1.8.1.1
Short Press [CAL] Key	7. Confirm the sample is 100% ○ Three position to display as: (Example:200mg) Upper left display the present weight, Upper right display the sample's weight, Main window displays 100%.	200.000 200.000 100.000 %	
	8. Take sample away and put any other sample on pan ○ Three position to display as: (Example:158mg) Upper left display 158mg, Upper right display the sample's weight 200mg, Main window displays 79%. ○ Remove the reference sample and add the unknown sample to determine its relative weight and percentage.	158.000 200.000 79.000 %	
Press and Hole [TARE] Key	9. Exit the percentage measurement		

● Quick Restart: exit the present percentage measurement and restart the new one, press and hold [MENU] key can restart the step 1, short press [CAL] to enter into step 3.

Note: The grey color words explain the signal's meaning which flash on the window.

(2) Instance of Percentage Measurement with Input Weight

Key (Order)	Step Explanation	LCD Screen Display	Menu Level and Code
Press and Hole [MENU] Key	1. Enter Into Menu System	-- h0dE --	1.
Short Press [CAL] Key	2. Display Counting Menu	- COUNT -	1.1.
Short Press [MENU] Key Seven Times	3. Enter Into Percentage Measurement Display signal "%" on window	PERCENT %	1.8.
Short Press [CAL] Key	4. Display Percentage Measurement Menu	SAMPLE %	1.8.1
Short Press [MENU] Key	5. Select percentage weighing mode with (Input)	INPUT %	1.8.2.
Short Press [CAL] Key	6. Input the percentage sample's weight manually (Example: 200mg) ○ Setting Way: Press [UNIT] key to move digit, press [PRINT] to increase the number and press [CAL] key to confirm.	200000 g	1.8.2.1
Short Press [CAL] Key	7. Confirm the sample is 100% ○ Three position to display as: (Example: 200mg) Upper left display the present weight, Upper right display the setting weight 200mg, Main window displays 0%.	0.000 200.000 0000 %	
	8. Take sample away and put any other sample on pan ○ Three position to display as: (Example: 158mg) Upper left display 158mg, Upper right display the setting weight 200mg, Main window displays 79%. ○ Remove the reference sample and add the unknown sample to determine its relative weight and percentage.	158.000 200.000 79.000 %	
Press and Hole [TARE] Key	9. Exit the percentage measurement		

● Quick Restart: exit the present percentage measurement and restart the new one, press and hold [MENU] key can restart the step 1, short press [CAL] to enter into step 3.

Note: The grey color words explain the signal's meaning which flash on the window.

Density Measurement Function (Menu Code: 1.9.)

Purpose

Use this function can calculate the solid or liquid material's density. (Need to fit with our company's hydrostatic sets)

Solid Material Density Measurement (Menu code:1.9.1, operating step page No.25)

Step One: Use Density kit to measure the sample weight in air.
Step Two: Measure the sample weight in water. (The liquid's density should be known)

Liquid Material Density Measurement (Menu code:1.9.2, operating step page No.26)

The standard sample's cubic meter should be known if using density kit to measure the liquid's density.
U need to input the sample's volume into machine. The machine can save the lately sample data and ready for ser using any time.

Step One: Measure the sample weight in air.
Step Two: Measure the sample weight in water.

Saving standard liquid's density previously (Menu code: 1.9.3.1.01~10)

Machine can save 10 kinds of standard liquid's density value.
Saving way: Press (UNIT) Key to move cursor, press (PRINT) to cycle and select value. Press (MENU) Key to save another value.

Density Kit (optional) assemble step

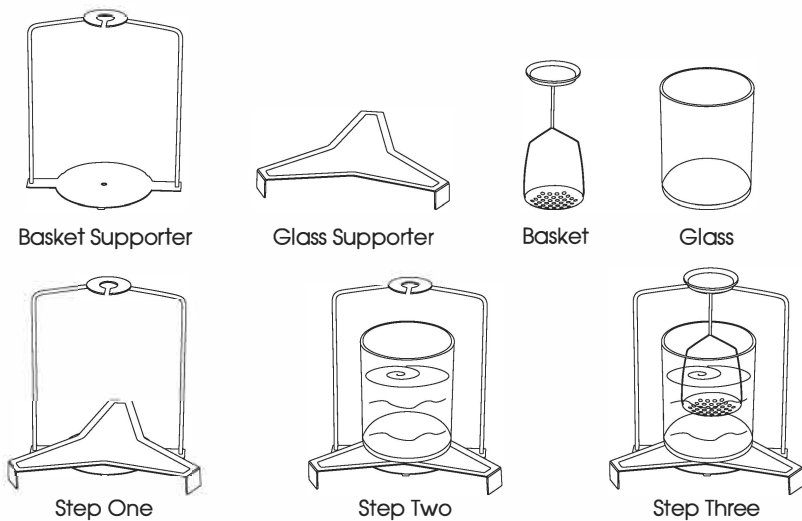



(1) Solid Density Measurement Instance

Key (Order)	Step Explanation	LCD Screen Display	Menu Level and Code
Press and Hole [MENU] Key	1. Enter Into main menu	- - 0.0000 - -	1.
Short Press [CAL] Key	2. Display Counting Menu	- [COUNT] -	1.1.
Short Press [MENU] Key Eight Times	3. Display Density Menu The signal flash on the upper left of window	DENSITY	1.9.
Short Press [CAL] Key	4. Enter into Solid Density Measurement program	- SOLID -	1.9.1.
Short Press [CAL] Key	5. Start the solid density program and select a density value of standard liquid. ○ User can set liquid density: Press [UNIT] key to move cursor, press [PRINT] to cycle and select value. ○ Select the 10 previous set liquid densities: Short press [UNIT] 7 times, all digits will flash. Press [PRINT] key can cycle and select 10 liquid densities which were set previously.	0099988	1.9.1.1
Short Press [CAL] Key	6. Machine will clue user to measure sample in air ○ Three position to display as: Upper left display Air, Upper right display the time, Main window displays the weight	Air 09:39:08 000g	
Short Press [CAL] Key	7. Weight sample in air. (Example: The weight result is 118.45mg in air)	Air 118.45g	
Short Press [CAL] Key	8. Machine will record the air weighing data ○ Three position to display as: Upper left display Liquid, Upper right display the time, Main window displays the weight	Liquid 09:39:58 118.45g	
Short Press [CAL] Key	9. Take the sample away, Machine will clue user to measure material in water	Liquid 000g	
Short Press [CAL] Key	10. Put sample in water and weigh it. (Example: the weight result is 20.70mg in water)	Liquid 20.70g	
Short Press [CAL] Key	11. Machine will record the water weighing data; calculate the sample's density and display the density value at the same time ○ (If need to measure density again, please repeat step 6-11)	Density 1.21158	
Press and Hole [TARE] Key	12. Exit the Solid Density Measurement		

● Quick Restart: exit the present density measurement and restart the new one, press and hold [MENU] key can restart the step 1, short press [CAL] to enter into step 3.

Note: The grey color words explain the signal's meaning which flash on the window.

(2) Liquid Density Measurement Instance

Key (Order)	Step Explanation	LCD Screen Display	Menu Level and Code
Press and Hole [MENU] Key	1. Enter Into main menu	--ñodE-	1.
Short Press [CAL] Key	2. Display Counting Menu	-COUNT-	1.1.
Short Press [MENU] Key Eight Times	3. Display Density Menu <i>The signal flash on the upper left of window</i>	dENSI tY	1.9.
Short Press [CAL] Key	4. Display Solid Density Menu	-SOLID-	1.9.1.
Short Press [MENU] Key	5. Enter into Liquid Density Measurement program	-LIQUID	1.9.2.
Short Press [CAL] Key	6. Input the standard sample's volume ○ Input way: Press [UNIT] key to move cursor, press [UNIT] key to cycle the number and select. Press [CAL] key to confirm it.	1000000	1.9.2.1
Short Press [CAL] Key	7. Machine will clue user to measure material in air ○ Three position to display as: <i>Upper left display Air, Upper right display the time, Main window displays the weight</i>	Air 09:39:08 000g	
	8. Measure Liquid container in air. (Example: 118.45mg)	Air 118.45g	
Short Press [CAL] Key	9. Machine will record the air weighing data and clue user on that measure container's weight in water. ○ Three position to display as: <i>Upper left display Liquid, Upper right display the time, Main window displays the weight</i>	LIQUID 09:39:58 118.45g	
 	10. Take the sample away and then machine will clue user to measure sample in water	LIQUID 000g	
	11. Measure Liquid container in water (Example : 20.70mg)	LIQUID 20.70g	
Short Press [CAL] Key	12. Machine will record the water weighing data; calculate the liquid's density and display the density value at the same time. ○ (If need to measure different material's density, please repeat step 7-12)	d---9cc 977300	
Press and Hole [TARE] Key	13. Exit the Liquid Density Measurement		

● Quick Restart: exit the present density measurement and restart the new one, press and hold [MENU] key can restart the step 1, short press [CAL] to enter into step 3.

Note: The grey color words explain the signal's meaning which flash on the window.

Basic Function Setting (Menu Code: 2)

Purpose

Operator can set machine basic function by selecting parameter in Menu.

Automatic Double Weighing Rang, Dual Precision Function Setting

(Menu Code: 2.1.)

This series machine has automatic double weighing range and dual precision. (some type didn't has this function). The machine default set the weighing range and precision. Please refer to Page 8~9 to know more detail specification of second weighing range and precision.

For the temporary needs of user, the machine will switch to second weighing range and precision automatically when the weighing sample's weight over the max capacity of machine.

Instance

Key (Order)	Step Explanation	LCD Screen Display	Menu Level and Code
Press and Hole [MENU] Key	1. Display Menu	--ñodE-	1.
Short Press [MENU] Key	2. Enter Into Setting Menu	--BASE-	2.
Short Press [CAL] Key	3. Display weighing range and precision menu	-SCALE-	2.1.
Short Press [CAL] Key	4. Display the code of first weighing range and precision ○ Example: the display flash: 3203, among them, 320 means first weighing range is 320mg, last number 3 means machine's precision is three zero after the decimal point (0.001mg) ○ The machine will switch to second weighing range and precision automatically when the weighing sample's weight over the max capacity of machine. The second weighing range and precision also mention on the label which at side of machine.	f 3203	2.1.1
Short Press [TARE] Key Three Times	5. Exit the checking menu and return to standby		

Note: The grey color words explain the signal's meaning which flash on the window.

Turn On/Off the Units (Menu Code: 2.2)

Operator can turn on or off the unit to display or hide the relative weighing units.

Instance

Key (Order)	Step Explanation	LCD Screen Display	Menu Level and Code
Press and Hold [MENU] Key	1. Display Menu	-- n odE-	1.
Short Press [MENU] Key	2. Enter Into Setting Menu	-- b ASE-	2.
Short Press [CAL] Key	3. Display weighing range and precision menu	- S CALE-	2.1.
Short Press [MENU] Key	4. Enter Into Unit Turn ON/OFF Mode	-- U ni T-	2.2.
Short Press [CAL] Key	5. Display Unit ct and flash "ON" (Turn on)	22.10.1 09:20:08 ct-ON	
	○ Three position to display as: Upper left display the menu code, Upper right display the time, Main window displays the unit status.		
Short Press [PRINT] Key	6. Display Unit ct and flash "OFF" (Turn off)	ct-OFF	2.2.1.01
Short Press [MENU] Key	7. Cycle to another unit oz and flash "ON"	oz-ON	2.2.1.02
Short Press [PRINT] Key	8. Display Unit oz and flash "OFF"	oz-OFF	2.2.1.02
	○ Repeat Step 7-8 can change unit on/off one by one as follow : ct, oz, ozt, dwt, GN, lb, N, dr, tIT, tIs, tIH, T, T/A/R, /A/R, ms, bat, mom, /lb, kg		
	○ The default setting is all units was turn on.		
Short Press [CAL] Key	9. Confirm that turn on or off the units	-- U ni T-	2.2.
Short Press [TARE] Key Two Times	10. Setting Finished and return to Standby		

Note: The grey color words explain the signal's meaning which flash on the window.

Date Setting (Menu Code: 2.3.)

Operator can setup machine date by setting menu.

Instance (Example: 2015Year-05Month-10Day)

Key (Order)	Step Explanation	LCD Screen Display	Menu Level and Code
Press and Hold [MENU] Key	1. Display Menu	-- n odE-	1.
Short Press [MENU] Key	2. Enter Into Setting Menu	-- b ASE-	2.
Short Press [CAL] Key	3. Display weighing range and precision menu	- S CALE-	2.1.
Short Press [MENU] Key Two Times	4. Enter Into Date Setting	-- d ATE-	2.3
Short Press [CAL] Key	5. Display Year	YEAR-15	2.3.1
	○ Operator can set year by : Press [UNIT] key to move cursor and press [PRINT] to cycle and select number.		
Short Press [MENU] Key	6. Display Month	MON--05	2.3.2
	○ Operator can set month by : Press [UNIT] key to move cursor and press [PRINT] to cycle and select number.		
Short Press [MENU] Key	7. Display Day	DAY--10	2.3.3
	○ Operator can set day by : Press [UNIT] key to move cursor and press [PRINT] to cycle and select number.		
Short Press [CAL] Key	8. Confirm the date and return to previous menu	-- d ATE-	2.3.
Short Press [TARE] Key Two Times	9. Finish Setting and return to Standby		

Note: The grey color words explain the signal's meaning which flash on the window.

Time Setting (Menu Code: 2.4.)

Operator can setup machine date by setting menu.

Instance (Example: 20 :15 : 50)

Key (Order)	Step Explanation	LCD Screen Display	Menu Level and Code
Press and Hold [MENU] Key	1. Display Menu	--n0dE-	1.
Short Press [MENU] Key	2. Enter Into Setting Menu	--bA5E-	2.
Short Press [CAL] Key	3. Display weighing range and precision menu	-SCALE-	2.1.
Short Press [MENU] Key Three Times	4. Enter Into Time Setting Mode	--T1nE-	2.4
Short Press [CAL] Key	5. Display Hour ○ Operator can set hour by : Press [UNIT] key to move cursor and press [PRINT] to cycle and select number.	Hour -20	2.4.1
Short Press [MENU] Key	6. Display Minutes ○ Operator can set minutes by : Press [UNIT] key to move cursor and press [PRINT] to cycle and select number.	n1n--15	2.4.2
Short Press [MENU] Key	7. Display Second ○ Operator can set second by : Press [UNIT] key to move cursor and press [PRINT] to cycle and select number.	SEC--50	2.4.3
Short Press [MENU] Key	8. Display Time Mode ○ Operator can press [PRINT] key to select 24 hours or 12 hours.	H----24	2.4.4
Short Press [CAL] Key	9. Confirm the Time and return	--T1nE-	2.4.
Short Press [TARE] Key Two Times	10. Setting finished and return to standby		

● The menu code: 2.4.5 can set the time goes fast or slow. Press [UNIT] key to move cursor and press [PRINT] to cycle and select number.

Note: The grey color words explain the signal's meaning which flash on the window.

Correct Temperature (Menu Code: 2.5.)

Operator can set the display temperature by setting menu.

Instance

Key (Order)	Step Explanation	LCD Screen Display	Menu Level and Code
Press and Hold [MENU] Key	1. Display Menu	--n0dE-	1.
Short Press [MENU] Key	2. Enter Into Setting Menu	--bA5E-	2.
Short Press [CAL] Key	3. Display weighing range and precision menu	-SCALE-	2.1.
Short Press [MENU] Key Four Times	4. Enter Into Correct Temperature Mode ○ Operator can set temperature by : Press [UNIT] key to move cursor and press [PRINT] to cycle and select number. ○ It only can adjust the machine's temperature and the adjustment range is within ± 1.9	TAD] 0.1	2.5.
Short Press [CAL] Key	5. Confirm the temperature and return	--bA5E-	2.
Short Press [TARE] Key	6. Finish the setting and return to standby		

Note: The grey color words explain the signal's meaning which flash on the window.

Backlight On/Off Setting (Menu Code: 2.6)

Operator can turn on/off/auto backlight by setting menu.

Instance

Key (Order)	Step Explanation	LCD Screen Display	Menu Level and Code
Press and Hole [MENU] Key	1. Display Menu	--n0dE-	1.
Short Press [MENU] Key	2. Enter Into Setting Menu	--bA5E-	2.
Short Press [CAL] Key	3. Display weighing range and precision menu	-SCALE-	2.1.
Short Press [MENU] Key Five Times	4. Enter into backlight setting and flash "ON"	bl--ON	2.6
Short Press [PRINT] Key	5. Backlight turn on/off automatically and flash "AUT"	bl--Aut	2.6
Short Press [CAL] Key	6. Confirm the backlight setting and return	--bA5E-	2.
Short Press [TARE] Key	7. Finish the setting and return to standby		

Buzzer On/Off Setting (Menu Code: 2.7)

Operator can turn on/off the buzzer sound by setting menu.

Instance

Key (Order)	Step Explanation	LCD Screen Display	Menu Level and Code
Press and Hole [MENU] Key	1. Display Menu	--n0dE-	1.
Short Press [MENU] Key	2. Enter Into Setting Menu	--bA5E-	2.
Short Press [CAL] Key	3. Display weighing range and precision menu	-SCALE-	2.1.
Short Press [MENU] Key Six Times	4. Enter into buzzer setting and flash "ON"	beep ON	2.7
Short Press [PRINT] Key	5. Turn off buzzer and flash "OFF"	beepOFF	2.7
Short Press [CAL] Key	6. Confirm the buzzer setting and return	--bA5E-	2.
Short Press [TARE] Key	7. Finish the setting and return to standby		

Note: The grey color words explain the signal's meaning which flash on the window.

Language Setting (Menu Code: 2.8)

Operator can set some function's interface with Chinese or English language by setting this menu.

Instance

Key (Order)	Step Explanation	LCD Screen Display	Menu Level and Code
Press and Hole [MENU] Key	1. Display Menu	--n0dE-	1.
Short Press [MENU] Key	2. Enter Into Setting Menu	--bA5E-	2.
Short Press [CAL] Key	3. Display weighing range and precision menu	-SCALE-	2.1.
Short Press [MENU] Key Seven Times	4. Enter into Language setting and flash "Cn" (Chinese)	LANG-Cn	2.8
Short Press [PRINT] Key	5. Flash "En" and language switch to English	LANG-En	2.8
Short Press [CAL] Key	6. Confirm the setting and return	--bA5E-	2.
Short Press [TARE] Key	7. Finish the setting and return to standby		

Note: The grey color words explain the signal's meaning which flash on the window.

Eighth Part: Communication Setting

Communication Function Setting (Menu Code: 3)

Purpose

Operator can select the communication way by setting the menu.

Baud Rate Setting (Menu Code: 3.1)

Select different baud rate for different output required.

Machine ID No. Setting (Menu Code: 3.2)

For recognize each machine by different ID No.

FMT Setting (Data Frames Format) (Menu Code: 3.3)

Select different data format for different output required.

COM Setting (Communication Way) (Menu Code: 3.4)

Select different communication way for output different signal.

PRT Setting (Print Way) (Menu Code: 3.5)

Select different printing way for different output.

KEY Setting (Transfer the Signal) (Menu Code: 3.6)

Select the menu and switch the signal from computer to other equipment (such as printer), or send signal to both at the same time.

COM ITEM (To Turn On/Off the Communication Data) (Menu Code: 3.7)

Operator can turn on or off the any out put RS232 data.

PRT ITEM (To Turn On/Off the Printing Data) (Menu Code: 3.8)

Operator can turn on or off the any out put printing data.

Communication Setting

Instance (Menu Code: 3.1~3.6)

Key (Order)	Step Explanation	LCD Screen Display	Menu Level and Code
Press and Hold [MENU] Key	1. Display Menu	--n0dE--	1.
Short Press [MENU] Key Two Times	2. Enter into Communication Setting	--[oññ--	3.
Short Press [CAL] Key	3. Enter into Baud rate Setting	bAud-96	3.1
	○ Press [PRINT] key and select different baud rate in turns: 12: 1200bps, 24: 2400bps, 48: 4800bps, 96: 9600bps		
Short Press [MENU] Key	4. Enter into Machine ID Setting	Id--255	3.2
	○ Operator can set Machine ID from 001 to 255, Press [UNIT] key to move the cursor and press [PRINT] key to select the number.		
Short Press [MENU] Key	4. Enter Into Data frames format Setting	Fñt-R5C	3.3
	○ Press [PRINT] key can select ASC (ASCII format) or ATU (Modbus ATU).		
Short Press [MENU] Key	4. Enter Into Communication Way Setting	Coñ KEY	3.4
	○ Press [PRINT] key can select : NON: turn off communication, CON: communicate continuously, STY: communicate while steady, KEY: communicate only press [PRINT] key, SOFT: communicate with software, Txxx: communicate every XX seconds (Can set time manually).		
Short Press [MENU] Key	4. Print Way Setting	Prt KEY	3.5
	○ Press [PRINT] key can select : NON: turn off print, KEY: print only press [PRINT] key, SOFT: print by software order, Txxx: print every XX seconds (Can set time manually).		
Short Press [MENU] Key	4. Peripheral Equipment Setting	KEY-Prt	3.5
	○ Press [PRINT] key can select : KEY.PRT, KEY.COM, KEY.ALL, KEY.NON ○ Short Press [CAL] key to select KEY.PRT and return: Machine send signal to printer when press [PRINT] key. Short Press [CAL] key to select KEY.COM and return: Machine send signal to computer when press [PRINT] key. Short Press [CAL] key to select KEY.ALL and return: Machine send signal to printer and computer both when press [PRINT] key. Short Press [CAL] key to select KEY.NON and return: Press [PRINT] key NO SIGNAL CAN SEND OUT.		
Short Press [CAL] Key	5. Confirm and return to previous menu	--[oññ--	3.
Short Press [TARE] Key	6. Finish Setting and return to standby		

● The grew color parts is the following operation after Step 1-3 baud rate Setting.

Note: The grey color words explain the signal's meaning which flash on the window.

COM ITEM Instance (Menu Code: 3.7)

Key (Order)	Step Explanation	LCD Screen Display	Menu Level and Code
Press and Hold [MENU] Key	1. Display Menu	--n0dE-	1.
Short Press [MENU] Key Two Times	2. Enter into Communication Setting	--[onñ-	3.
Short Press [CAL] Key	3. Enter into Baud rate Setting	bAud-96	3.1.
Short Press [MENU] Key Six Times	4. Enter into output data turn On/Off menu	[onñ tEñ	3.7.
Short Press [CAL] Key	5. Enter into turn On/Off output data of Type	3.7.1.0.1 095808	
	<ul style="list-style-type: none"> Three position to display as: Upper left display the menu code, Upper right display the time, Main window displays the data's status. The default setting is turn ON and output all machine's data. Operator can press [PRINT] to turn OFF each output data. 	TYPE ON	
Short Press [MENU] Key	6. Enter into turn On/Off output data of ID	Id ON	3.7.1.02
Short Press [MENU] Key	7. Enter into turn On/Off output data of Date	dATE ON	3.7.1.03
Short Press [MENU] Key	8. Enter into turn On/Off output data of Time	TiME ON	3.7.1.04
Short Press [MENU] Key	9. Enter into turn On/Off output data of Temperature	TEMP ON	3.7.1.05
Short Press [MENU] Key	10. Enter into turn On/Off output data of Battery Status	POW ON	3.7.1.06
Short Press [MENU] Key	11. Enter into turn On/Off output data of Weighing Mode	n0dE ON	3.7.1.07
Short Press [MENU] Key	12. Enter into turn On/Off output data of Reference Weight Mass	rEF ON	3.7.1.08
Short Press [MENU] Key	13. Enter into turn On/Off output data of Weighing Status	SrAF ON	3.7.1.09
Short Press [MENU] Key	14. Enter into turn On/Off output data of Weighing Step	StEP ON	3.7.1.10
Short Press [MENU] Key	15. Enter into turn On/Off output data of Tare Status	TAr ON	3.7.1.11
Short Press [MENU] Key	16. Enter into turn On/Off output data of Zero Status	ZErO ON	3.7.1.12
Short Press [MENU] Key	17. Enter into turn On/Off output data of Weight	wEt ON	3.7.1.13
Short Press [CAL] Key	18. Confirm the setting and return	[onñ tEñ	3.7.
Short Press [TARE] Key Two Times	19. Finish the setting and return to standby		

Note: The grey color words explain the signal's meaning which flash on the window.

PRT ITEM Instance (Menu Code: 3.8)

Key (Order)	Step Explanation	LCD Screen Display	Menu Level and Code
Press and Hold [MENU] Key	1. Display Menu	--n0dE-	1.
Short Press [MENU] Key Two Times	2. Enter into Communication Setting	--[onñ-	3.
Short Press [CAL] Key	3. Enter into Baud rate Setting	bAud-96	3.1.
Short Press [MENU] Key Seven Times	4. Enter into output data turn On/Off menu	Prt tEñ	3.8.
Short Press [CAL] Key	5. Enter into turn On/Off output data of Type	3.8.1.0.1 095808	
	<ul style="list-style-type: none"> Three position to display as: Upper left display the menu code, Upper right display the time, Main window displays the data's status. The default setting is turn ON and output all machine's data. Operator can press [PRINT] to turn OFF each output data. 	TYPE ON	
Short Press [MENU] Key	6. Enter into turn On/Off output data of ID	Id ON	3.8.1.02
Short Press [MENU] Key	7. Enter into turn On/Off output data of Date	dATE ON	3.8.1.03
Short Press [MENU] Key	8. Enter into turn On/Off output data of Time	TiME ON	3.8.1.04
Short Press [MENU] Key	9. Enter into turn On/Off output data of Temperature	TEMP ON	3.8.1.05
Short Press [MENU] Key	10. Enter into turn On/Off output data of Battery Status	POW ON	3.8.1.06
Short Press [MENU] Key	11. Enter into turn On/Off output data of First Dividing Line	-- ON	3.8.1.07
Short Press [MENU] Key	12. Enter into turn On/Off output data of Weighing Mode	n0dE ON	3.8.1.08
Short Press [MENU] Key	13. Enter into turn On/Off output data of Reference Weight Mass	rEF ON	3.8.1.09
Short Press [MENU] Key	14. Enter into turn On/Off output data of Weighing Status	SrAF ON	3.8.1.10
Short Press [MENU] Key	15. Enter into turn On/Off output data of Weighing Step	StEP ON	3.8.1.11
Short Press [MENU] Key	16. Enter into turn On/Off output data of Tare Status	TAr ON	3.8.1.12
Short Press [MENU] Key	17. Enter into turn On/Off output data of Zero Status	ZErO ON	3.8.1.13
Short Press [MENU] Key	18. Enter into turn On/Off output data of Weight	wEt ON	3.8.1.14
Short Press [MENU] Key	19. Enter into turn On/Off output data of Second Dividing Line	---- ON	3.8.1.15
Short Press [MENU] Key	20. Enter into turn On/Off output data of Signature	SIGN ON	3.8.1.16
Short Press [CAL] Key	21. Confirm the setting and return	[onñ tEñ	3.8.
Short Press [TARE] Key Two Times	22. Finish the setting and return to standby		

Note: The grey color words explain the signal's meaning which flash on the window.

Print Data of Weighing Mode (Example: 2000g/0.01)

TYPE:20002	Machine Type
ID:1	Identification
DATE:15-05-16	Date
TIME:00-08-08	Time (From measuring)
TEMP:20.8C	Room Temperature
BAT:FULL(EXT)	Power Status
-----	Broken Line
MODE:NORMAL	Mode
REF:1000.00g	Calibration Weight Mass
STATUS:STEADY	Present Status
STEP:NONE	Present Step
TARE:NONE	Tare Status
ZERO:NATURAL	Zero Status
WT:0.00g	Weighing Result
----COMPLETE----	END
SIGNATURE:	Signature
	Blank

Machine Weighing Configuration Setting (Menu Code: 4)

Purpose

Operator can set the machine basic weighing config to change the weighing capability to reach different required.

Zeroing Range Setting (Menu Code: 4,1)

Operator can increase or decrease the zeroing range for they need.

Tracking Range Setting (Menu Code: 4,2)

Operator can increase or decrease tracking range for they need.

Sensitivity Level Setting (Menu Code: 4,3)

Operator can adjust the sensitivity by increase or decrease the level. Level 1 is the lowest sensitivity and level 6 is the highest.

Speed Level Setting (Menu Code: 4,4)

Operator can adjust the weighing response time by increase or decrease the level. Level 1 is the slowest weighing response speed and level 3 is the fastest (Default and recommend setting: Level 2)

Anti-Vibration level Setting (Menu Code: 4,5)

Operator can adjust the weighing response time and anti-vibration strength by increase or decrease the level.

The higher level comes with higher anti-vibration. Level 1 has fast weighing speed and weak anti vibration. Level 7 has strong anti vibration and low weighing speed.

Instance (Menu Code: 4,1~4,5)

Key (Order)	Step Explanation	LCD Screen Display	Menu Level and Code
Press and Hold [MENU] Key	1. Display the Menu	--n0dE-	1.
Short Press [MENU] Key Three Times	2. Enter into Configuration Setting	-SEtUP-	4.
Short Press [CAL] Key	3. Enter into Zeroing Range Setting ○ Press [PRINT] key can set Zeroing Range from 0.0 to 6.0	ZEro-00	4.1
Short Press [MENU] Key	4. Enter into Tracking Range Setting ○ Press [PRINT] key can set Tracking Range from 0.0 to 6.0	StDY-05	4.2
Short Press [MENU] Key	4. Enter into Sensitivity Level Setting ○ Press [PRINT] key can set Sensitivity Level from 1 to 6	SENS--1	4.3
Short Press [MENU] Key	4. Enter into Speed Level Setting ○ Press [PRINT] key can set Speed Level I from 1 to 3	SPEED-2	4.4
Short Press [MENU] Key	4. Enter into Anti-Vibration Level Setting ○ Press [PRINT] key can set Anti-Vibration level from 1 to 7	FILT--1	4.5
Short Press [CAL] Key	5. Confirm the setting and return	-SEtUP-	4.
Short Press [TARE] Key	6. Finish the setting and return to standby		

● The grew color parts is the following operation after Step 1-3 Zeroing Range Setting.

Note: The grey color words explain the signal's meaning which flash on the window.

● The instance of how the automatic calibration analytical balance start to calibrate itself. (Menu Code: 5)

The requirement of start up the machine's automatic internal calibration.
First: Nothing on weighing pan, no operation and stable on the zero.
Second: The machine will start up the automatic internal calibration function base on the factory default (or user-set) time and temperature range.

If machine not reach above requirements, it will pause or stop the automatic internal calibration.

Third: When machine start up the automatic internal calibration function , the screen will display "AutoCAL" (AutoCAL), the calibration device which inside the machine will activate to calibrate the machine and motor will sound "zizizi" (IT'S NORMAL) . DURING the calibration process, the machine's screen will display build-in weight mass's weight. And then the system will self-test scale and screen will display "-----". The whole calibration over when zero display on screen.

INSTANCE (Example: Y-124/223)

(1) The instance of setting automatic internal calibration parameter.

Key (Order)	Step Explanation	LCD Screen Display	Menu Level and Code
Press and Hold [MENU] Key	1. Display Menu	--n0dE-	1.
Short Press [MENU] Key Four Times	2. Display the menu of Automatic Internal Calibration Setting	AutoCAL	5.
Short Press [CAL] Key	3. Enter into Automatic Internal Calibration Setting ○ The factory default setting is Turn on it (ON). The machine will start up the automatic internal calibration function base on the factory default time and temperature range. ○ Press [PRINT] to turn off it (OFF) and then machine will come with internal calibration status.	AutoCAL ON	5.1
Short Press [MENU] Key	4. Enter into Manual Internal Calibration Setting ○ Press [PRINT] to select manual External Calibration (Hnd) or manual Internal Calibration.	KEY-Aut	5.2
Short Press [MENU] Key	4. Enter into Automatic Internal Calibration's Weight Deviation ○ Press [PRINT] and [UNIT] can circle from 0d to 50d of the maximum deviation of initial zero tracking. (Example: if set 5d, the machine will still calibrate itself even if left 5d on pan) .	CAL203d	5.3

Short Press [MENU] Key	4. Enter into Automatic Internal Calibration Delay Time Setting	DELA02	5. 4
	<ul style="list-style-type: none"> ○ The Automatic Internal Calibration Delay Function only workable when machine reach the requirement of time, temperature, weight deviation range. ○ Press [PRINT] key and [UNIT] key can circle and select from 0.1 to 5 minutes. 		
Short Press [MENU] Key	4. Enter into the Boot Automatic Calibration Setting	boot ON	5. 5
	<ul style="list-style-type: none"> ○ The factory default is turn on (ON), press [PRINT] can turn off (OFF) it. And then machine will not calibrate itself automatically when turn on. 		
Short Press [MENU] Key	4. Enter into Automatic Internal Calibration Time Setting	--- 60	5. 6
	<ul style="list-style-type: none"> ○ Press [PRINT] key and [UNIT] key can circle and select from 5 to 300mins or turn it off (OFF). 		
Short Press [MENU] Key	4. Enter into Enter into Automatic Internal Calibration Temperature Setting	--- 0.5	5. 7
	<ul style="list-style-type: none"> ○ Press [PRINT] key and [UNIT] key can circle and select from 0.5 to 3.0 °C turn it off (OFF). 		
Short Press [MENU] Key	4. Enter into Build-in Weight mass Adjustment Setting	REF 000	5. 8
	<ul style="list-style-type: none"> ○ Press [PRINT] key can circle and select from ± 0.01mg to 19.99mg of adjust the build-in weight mass's weight. ○ Press [UNIT] key to move the flash, press [PRINT] key to circle the setting value, "+" or "-" (Positive or Negative). 		
Short Press [CAL] Key	5. Confirm the setting and return	-SETUP-	5.
Short Press [TARE] Key	6. Finish the setting and return to standby		



● The grew color parts is the following operation after Step 1-3 Automatic Internal Calibration Setting.

(2) The Instance of Automatic Internal Calibration machine operate manual Internal Calibration.





Key (Order)	Step Explanation	LCD Screen Display
Short Press [TARE] Key	1. Machine tare the weight	0.0000 g
Press and Hold [CAL] Key	2. Display internal calibration signal, flash Aut.CAL	Aut.CAL
Release [CAL] Key	3. After several seconds, the machine display zero, then the calibration finished	0.0000 g

Note: The grey color words explain the signal's meaning which flash on the window.

(3) The Instance of Automatic Internal Calibration machine operate External Span Calibration.

Key (Order)	Step Explanation	LCD Screen Display
Short Press [TARE] Key	1. Machine tare	0.0000 g
Synchronous Press and Hold [MENU] [CAL] Key	2. Display span calibration signal Flash the required weight mass value: 100g	100.0000 g
	3. Put required weight mass on pan. After 5 seconds, display the weight of it.	100.0000 g
	4. Take the weight mass away (Span calibration finished)	0.0000 g

(4) The Instance of Automatic Internal Calibration machine operate External Linearity Calibration. (Please DO NOT linearity calibrate the machine if you don't have match weight mass)

Key (Order)	Step Explanation	LCD Screen Display
Short Press [TARE] Key	1. Machine tare	0.0000 g
Synchronous Press and Hold [MENU] [CAL] Key	2. Display Span CAL signal Flash 100mg signal	100.0000 g
Press and Hold [MENU] Key	3. Display Linearity CAL signal Flash 120mg signal	120.0000 g
	4. Put required weight mass on pan Display 120mg after 5 seconds	120.0000 g
	5. Take weight mass away Linearity calibration step Flash 100mg signal	100.0000 g
	6. Put required weight mass on pan Display 100mg after 5 seconds	100.0000 g
	○ The balance is preset to four internal linear calibration: 120mg, 100mg, 50mg, 20mg	
	7. Take weight mass away (Linearity calibration finished)	0.0000 g

Note: The grey color words explain the signal's meaning which flash on the window.

● **External Calibration Machine operate calibration function** (no menu code)



Only when machine reach following requirements can operate the calibration.

- First: Nothing on Weighing Pan. Second: Machine was Tare. Third: Machine is stable on Zero.





The machine will show ERROR if do not reach the above conditions.

The machine will show the needed weight mass value if reach the above conditions.

(1) Instance of External Span Calibration

Key (Order)	Step Explanation	LCD Screen Display
Short Press [TARE] Key	1. Machine tare	0.0000 g
Press and Hold [CAL] Key	2. Display span calibration signal Flash the required weight mass value: 100mg	100.0000 g
	3. Put required weight mass on pan. After 5 seconds, display the weight of it.	100.0000 g
	4. Take the weight mass away (Span calibration finished)	0.0000 g

(2) Instance of External Linearity Calibration (Please DO NOT operate the Linearity Calibration if you don't have matched weight mass)

Key (Order)	Step Explanation	LCD Screen Display
Short Press [TARE] Key	1. Machine tare	0.0000 g
Press and Hold [CAL] Key	2. Display Span CAL signal Flash 100mg signal	100.0000 g
Press and Hold [MENU] Key	3. Display Linearity CAL signal Flash 120mg signal	120.0000 g
	4. Put required weight mass on pan Display 120mg after 5 seconds	120.0000 g
	5. Take weight mass away Linearity calibration step Flash 100mg signal	100.0000 g
	6. Put required weight mass on pan Display 100mg after 5 seconds	100.0000 g
	○ The balance is preset to four internal linear calibration: 120mg, 100mg, 50mg, 20mg	
	7. Take weight mass away (Linearity calibration finished)	0.0000 g

Note: The grey color words explain the signal's meaning which flash on the window.

Restore the machine Config (Menu Code: 6)

Purpose

Operator can restore the machine to factory setting by input the code in menu.

Instance

Key (Order)	Step Explanation	LCD Screen Display	Menu Level and Code
Press and Hold [MENU] Key	1. Display Menu	- - 0000 - -	1 .
Short Press [MENU] Key Five Times	2. Enter Into restore factory setting function	- [Conf] G	5 .
Short Press [CAL] Key	3. Enter Into the input code ○ Press [UNIT] key to move the cursor and press [PRINT] key to select the number. THE CODE IS: 8888	[0]0000	5 . 1
Short Press [CAL] Key	4. Confirm and return to previous menu	- [Conf] G	5 .
Short Press [TARE] Key	5. Finish Setting and return to standby		

⚠ For the convenience of operator remember the code, the restore factory setting code all is: 8888. Operator can not set other code.

Note: The grey color words explain the signal's meaning which flash on the window.

Twelfth: Operating Menu

○ Factory Settings

	Menu Level One	Menu Level Two	Menu Level Three	Default Setting	Menu Items	
Table	1. Application	1.1. Counting	1.1.1	○	Sample's quantity 20pcs	
			1.1.2		Set sample's quantity manually	
		1.2. Computing Price	1.2.1		Set sample's unit weight	
			1.2.2		Set sample's unit price	
		1.3. High-Low Limit Weighing	1.3.1	○	OUT (Out the limit)	
		1.4. Gross/Net/Tare Weight Weighing	1.4.1	○	Set sample's tare weight	
			1.4.2		Set sample's tare weight manually	
		1.5. Accumulating			Accumulate weight and tracing records	
		1.6. Dynamic Weighing	1.6.1	○	Dynamic weighing with 10 seconds	
		1.7. Peak Holding	1.7.1	○	Count the peak holding data	
			1.7.2~5		Other ways of record peak holding	
		1.8. Percentage Weighing	1.8.1	○	Percentage weighing with sample	
			1.8.2		Percentage weighing with set weight	
		1.9. Density Measurement	1.9.1	○	Density of Solid Sample	
			1.9.2		Density of Liquid Sample	
			1.9.3		List of saved standard liquid density	
		2. Basic Function	2.1. Automatic Dual Weighing Range	2.1.1	○	First Weighing Range
				2.2.1.01		Machine has 20 units available. They are: g, ct, oz, ozt, dwt, GN, lb, N, dr, tIT, tIs, tIH, T, T/A/R, /A/R, ms, bat, mom, /lb, kg
			2.2. Turn On/Off Units	2.2.1	○	Turn ALL unit ON
	2.3. Date Setting		2.3.1	○	Year	
			2.3.2	○	Month	
			2.3.3	○	Date	
	2.4. Time Setting		2.4.1	○	Hour	
			2.4.2	○	Minute	
2.4.3			○	Second		
2.4.4			○	24 hours mode		
2.4.5				Modify time speed		
2.5. Temperature Setting				Correct Temperature		
2.6. Backlight Setting			○	Turn On backlight		
2.7. Buzzer Setting			○	Turn On buzzer		
2.8. Language Setting			○	Chinese		

Menu Items Explanation

Menu Level Four	Menu Items Explanation
1.1.1.1	Operator can select 10, 20, 50, 100, 150, 200, 250, 500, 1000pcs in turns or any other number.
1.1.2.1	Operator can select 10, 20, 50, 100, 150, 200, 250, 500, 1000pcs in turns or any other number.
1.1.2.2	Flash the sample's quantity of last time or set the sample's quantity manually.
	Input the known sample's unit weight.
	Input the known sample's unit price.
	Operator can set the buzzer alarm terms: OUT (out the limit) or IN (in the limit).
1.4.1.1	Notice to put the tare weight's sample.
1.4.2.1	Notice to input the tare weight manually.
	Machine can accumulate the max weight up to 9999999g and trace the recent 100 times of weighing records.
	Operator can set 01, 02, 05, 10, 15, 20, 30, 40, 50, 60 seconds or any numbers from 0-99.
	Machine can record peak holding weighing time for 9999 times and trace the recent 100 times of weighing records.
	Peak Holding Weighing way with Time, TKEY (Press Key), TST1 (Very Stable), TST2 (Little Stable), TCON (Continuing).
1.8.1.1	Percentage weighing with sample.
1.8.2.1	Percentage weighing with set weight of sample.
1.9.1.1	Setting standard liquid's density. Operator can select the previously saved liquid density.
1.9.2.1	Machine can set a standard weight mass's density.
1.9.3.1	Can save the 10 groups different standard liquid's density.
	The machine will switch to second weighing range and precision automatically when the weighing sample's weight over the max capacity of machine.

Operating Menu

○ Factory Settings

Menu Items Explanation

	Menu Level One	Menu Level Two	Menu Level Three	Default Setting	Menu Items
Table	3. Communication	3.1. Baud Rate		○	Baud rate: 9600
		3.2. Machine ID		○	ID: 001
		3.3. Data Format		○	ASCII Format
		3.4. Communication Way		○	KEY (Manually)
		3.5. Printing Way		○	KEY (Manually)
		3.6. Output Data Way		○	Output data to printer
		3.7. Turn On/Off Communication Data	3.7.1	○	Turn ALL data ON
		3.8. Turn On/Off Printing Data	3.8.1	○	Turn ALL data ON
	4. Weighing Capability	4.1. Zeroing Range		○	Zeroing Range 1.5 / 2.0
		4.2. Tracking Range		○	Tracking Range 1.0 / 1.5
		4.3. Sensitivity Level Setting		○	Sensitivity Level 3
		4.4. Weighing Speed Setting		○	Speed Level 2 / 3
		4.5. Anti-Vibration Level Setting		○	Anti-Vibration Level 5
	5. Automatic Internal Calibration	5.1. Automatic Internal Calibration		○	ON (turn on)
		5.2. Manual Internal Calibration		○	Aut (Manual Internal Calibration)
		5.3. Deviation of initial zero tracking Setting of Internal Calibration		○	5d
		5.4. Automatic Calibration Delay Time Setting		○	0.2 Minutes
		5.5. Boot Automatic Calibration Setting		○	ON (turn on)
		5.6. Automatic Internal Calibration Time Setting		○	60 Minutes
		5.7. Automatic Internal Calibration Temperature Setting		○	0.5°C
5.8. Build-in Weight mass Adjustment Setting			○	0mg	
6. Restore Factory Setting	6.1. Restore Factory Setting		○	Code 8888	

Menu Level Four	Menu Items Explanation
	Operator can select baud rate from 12 (1200bps), 24 (2400bps), 48 (4800bps) and 96 (9600bps).
	Operator can set ID from 001- 255.
	Operator can set weighing data output format with ASC (ASCII) or ATU (Modbus ATU).
	Operator can set communication way of NON, CON, STY, KEY, SOFT, Txxx (001- 999 second).
	Operator can set print way of NON, KEY, SOFT, Txxx (001- 999 second).
	Operator can select RS232 data output way of KEY.COM (Computer), KEY.PRT (Printer), KEY.ALL (Computer and Printer), NON (No data output).
3.7.1.01	Operator can turn off the output data of type, ID, date, time, temperature, battery, mode, weight mass, status, step, tare, zero and weight in turns.
3.8.1.01	Operator can turn off the output data of type, ID, date, time, temperature, battery, fist dividing line, mode, weight mass, status, step, tare, zero, weight, second dividing line and signature in turns.
	Operator can set zeroing range: 0.0, 0.5, 1.0, 1.5, 2.0, 2.5, 3.0, 3.5, 4.0, 4.5, 5.0, 5.5, 6.0 in turns.
	Operator can set tracking range: 0.0, 0.5, 1.0, 1.5, 2.0, 2.5, 3.0, 3.5, 4.0, 4.5, 5.0, 5.5, 6.0 in turns.
	Operator can select sensitivity level with 1-6 level in turns. The higher level comes with higher sensitivity.
	Operator can select 1-3 speed level in turns. The higher level comes with faster speed.
	Operator can select anti-vibration level with 1-7 level. The higher level comes with higher anti-vibration.
	User can select ON (turn on), OFF (turn off).
	User can select Hnd (Manual External Calibration), Aut (Manual Internal Calibration).
	User can select the deviation of initial zero tracking parameter from 0, 1, 2, 4, 5, 6, 8, 10, 12, 15, 20, 25, 30, 35, 40 to 50d in turns.
	User can select the time from 0.1, 0.2, 0.3, 0.4, 0.5, 0.6, 0.8, 1.0, 1.2, 1.5, 2.0, 2.5, 3.0, 3.5, 4.0 to 5.0 minutes in turns.
	User can select ON (turn on) OFF (turn off).
	User can select the time from 5, 10, 15, 20, 30, 45, 60, 75, 90, 120, 150, 180, 210, 240, 270, 300 minutes or OFF (turn off) in turns.
	User can select the time from 0.1, 0.2, 0.3, 0.4, 0.5, 0.6, 0.7, 0.8, 0.9, 1.0, 1.2, 1.5, 1.8, 2.0, 2.5, 3.0°C or OFF (turn off) in turns.
	User can adjust the build-in weight mass's weight from ± 0.01mg to 19.99mg.
	Restore the factory setting code is 8888. Operator can not set other code.

Thirteenth: Proper Care and Maintenance

Repair

Only trained technician was authorized to repair the problem machine.

Clean

- Pull out the adapter from electrical outlet and cable from machine.
 - Use soft cloth with neutral cleanser to clean the machine housing.
 - Dry the housing with soft cloth and then take out the weighing pan and wash it.
 - When take up the weighing pan and bracket, make sure that don't broken the weighing system.
- ⚠ Do not let the liquid flow into machine.
- ⚠ Do not use the caustic cleanser.

Wash stainless steel surface

Use soft cloth or sponge to clean all stainless steel parts need to clean often and completely. Only home appliances cleanser available for clean the stainless parts. Wipe up the stainless steel parts surface first, wash up all leftover second and then dry it. Oil the stainless steel surface if necessary.

Guarantee

Do not ignore your warranty rights.

If machine have problem in guarantee period, please contact local distributor.

- We carry out The Guarantees strictly according to national regulation
- The guarantee period is one year from the date of sell. The guarantee machine is with correct install and usage, not man-made problem. Send back machine to local distributor or seller with proper packing (include warranty card). We will exchange a new one or repair and return machine to you within one week from we receive it.
- Battery, load cell and Magnetic cylinder is not including in guarantee range.
- If the problem machine exceed the guarantee time limit or was damage by man-made, we will charge the reasonable labor and material cost, delivery cost and any other possible cost.

Product Guarantee Elucidation

We guarantee that under proper using situation, We provide one year repairing service include material and technical support after selling date.

In Guarantee period, if machine broken or damage because of material or techniques, We will repair or replace the problem parts which has been proved. Please contact our Local office when machine need repairing.

The Guarantee Card will be inefficacy with wrong operating and not according as the operating manual. The Guarantee Card will be inefficacy with any damage or broken by unauthorized person's repairing or replacement.

We are not in charge with apparent or intentional disobeying the guarantee rule which cause machine any relevant or accidently broken.



INSTRUMENTOS DE MEDICIÓN INDUSTRIAL

LLÁMANOS

+52(81) 8115-1400 / +52(81) 8183-4300

LADA Sin Costo:

01 800 087 43 75

E-mail:

ventas@twilight.mx

www.twilight.mx

